

Hydraulic Excavators XE300U



Rated Power: 232 hp
Operating Weight: 71,650 lb
Bucket Capacity: 2.1 yd³

XCMG North America Corporation
5145 Schirlls Street, Las Vegas, NV 89118
Email: info@xcmgusa.com
Phone: (Las Vegas) 725-605-2777
(Houston) 346-409-2855
Web: www.xcmg-usa.com





Technical Specifications

Engine

Designed to deliver superior performance and fuel efficiency, the Cummins Stage V diesel engine fully meets the latest emissions regulations. To optimize machine performance, the engine uses high-pressure fuel injectors, a VGT™ turbocharger inter-cooler and electronic engine controls. A 4-cycle water-cooled, turbocharged, Exhaust Gas Recirculation (EGR) and Selective Catalytic Reduction (SCR) with a Diesel Particulate Filter (DPF).

Model	Cummins B6.7
No. of cylinders	6
Rated power at 2000 rpm	
(SAE J1995)	232 hp at 2000 rpm
(SAE J1349)	—
(ISO 9249)	200 hp/2000 rpm
Max. torque at 1500 rpm	700 ft-lb
Idle (low - high)	700 - 1200 rpm
Piston displacement	1.8 gal
Bore x stroke	4" x 5"
Starter	24 V x 7.8 kW
Batteries - Alternator	2 x 12 V, 150 Ah - 24 V, 70 A
Air filter	Donaldson the latest PSD air filter and pre-filtered dust separator

Weight

	Shoe width (in.)	Operating weight (lb)	Ground pressure (psi)
Triple grouser	24"	71,650.2	8.7
	28"	72,532.1	7.5
	31"	73,413.9	6.5

Hydraulic system

The XICS (XCMG Intelligent Control System) is the brain of the excavator - minimizing fuel consumption and enabling the efficiency of the hydraulic system to be optimized for all working conditions. To harmonize the operation of the engine and the hydraulics, the XICS is connected to the engine's electronic control unit (ECU) via a data transfer link.

- The hydraulic system enables independent and combined operations – 2-speed travel offers either increased torque or high travel speed
- Cross-sensing pump system and auto-deceleration system improve fuel efficiency.
- 8 work modes, 3 power modes - flow and pressure control of auxiliary hydraulic circuits from the control panel
- Computer-controlled pump flow control

> Pumps flow & system pressure

Main pumps, type:	2 x variable displacement tandem axial piston pumps
Maximum flow at 2000 rpm	2x84.5 gal/min
Pilot pump, type:	Gear pump
Maximum flow at 2000 rpm	6 gal/min
Relief valve settings:	
Pressure up	4,975/5,366 psi
Travel	4,685 psi
Swing	3,989 psi
Pilot	566 psi

Undercarriage

Extremely robust construction throughout - made of high-quality, durable materials, with all welded structures designed to limit stresses.

- Lifetime lubricated track rollers, idlers and sprockets fitted with floating seals
- Track shoes made of induction-hardened alloy with triple grouser
- Heat-treated connecting pins
- Hydraulic track adjuster with shock-absorbing tension mechanism

> Number of rollers and track shoes per side

Upper rollers (standard shoe)	2
Lower rollers	9
Number of links & shoes per side	48
Link pitch	216
Overall track length	16'2"

Cab

Optimal climate control is provided by the integrated air-conditioning and heating system. An automatically- controlled fan supplies the pressurized and filtered cab air, which is distributed throughout the cab from multiple vents. The fully adjustable heated air suspension operator's seat includes a seat belt. The operator can adjust the ergonomic seat and joystick console separately according to his preferences.

Note: Declared single-number noise emission values are the sum of measured values and the associated uncertainty, and they represent the upper boundaries of the range of values which is likely to occur in measurements.

> Noise emission

A-weighted emission sound pressure level at the operator's position, LpAd (ISO 6396:2008)	73 dB(A)
A-weighted sound power level, LwAd (2000/14/EC)	Declared : 104 dB(A) Measured : 103 dB(A)



Technical Specifications

Component weights

Item	Unit	XE300U	Remarks
Upper structure without front	lb	30,474.5	With counterweight
Lower structure assembly	lb	24,660.9	31" in shoe
Front assembly	lb	8,646.5	Without cylinder
Counterweight	lb	13,227.7	SLR counterweight:
Boom	ft/lb	20'2"/4,806.1	Including bushing
Arm	ft/lb	10'6"/2,610.3	Including bushing

Drive

An independent, high-torque axial piston motor through a planetary reduction gearbox drives each track. Two levers with foot pedals guarantee smooth travel with counter-rotation on demand. The track frame protects the travel motors with hydraulically released multi-disc brakes and planetary gears.

> Speed & traction

Travel speed (low - high)	2.0-3.3 mph
Maximum traction	57,981.6 lb
Maximum gradeability	35° / 70%

Buckets

Bucket type	Capacity (yd ³) SAE	Width (in.)		Weight (lb)	Boom 20'2"
		With side cutters	W/o side cutters		Arm 10'6"
GP	2.4yd ³	5'3"	5'3"	4'9"	Shoe 31" C
HD(std)	2.1yd ³	4'9"	4'9"	4'9"	B
SD	1.8yd ³	4'3"	4'3"	4'6"	A

Hydraulic cylinders

High-strength steel piston rods and cylinder bodies. Shock-absorbing (cushion) mechanism fitted in all cylinders for shock-free operation and extended piston life.

Cylinders	Quantity	Bore × rod diameter × stroke (in.)
Boom	2	5.5×3.9×55.4
Arm	1	6.3×4.3×64.8
Bucket	1	5.5×3.9×45.5

Swing mechanism

The swing mechanism uses an axial piston motor, driving a 2-stage planetary reduction gear for maximum torque bathed in oil.

- Swing bearing: single-row, shear type ball bearing with induction hardened internal gear
- Internal gear and pinion immersed in lubricant

> Swing speed & torque

Maximum swing speed	9.7 rpm
Maximum swing torque	76,096 lbf-ft

> Fluid capacities

Fuel tank	129.4 gal
Cooling system (radiator)	6.9 gal
Urea (DEF) tank	12.7 gal
Hydraulic oil tank	87.2 gal
Engine oil	7.9 gal
Swing drive	2.8 gal
Travel device	2 ×2.5 gal

GP: General purpose; HD: Heavy duty; SD: Severe duty;

A: Suitable for materials with a density less than or equal to 2100 kg/m³(131 lb/ft³)

B: Suitable for materials with a density less than or equal to 1800 kg/m³(112 lb/ft³)













C: Suitable for materials with a density less than or equal to 1500 kg/m³(93 lb/ft³)



Based on ISO 10567 and SAE J296, arm length without quick-coupler. For reference only.

Lifting Capacities

XE300U

Model: Rated lift capacity (lb) of XE300U standard track width: 11'1". W/o bucket

Lph(ft)	Lpr (ft)	A	9.8 ft.		14.8 ft.		19.7 ft.		24.6 ft.		27.5 ft.		Max. reach		
		B													
Boom 20'4" Arm 10'2" Shoe 24" Counterweight 13,228 lb	30.5												13,999	13,999	
	24.6							18,294	16,442				13,827	13,827	
	19.7							18,563	16,288				13,210	12,712	
	14.8			27,933	27,933	22,617	21,868	19,969	15,783		11,929	12,853	11,411		
	9.8			35,512	30,541	26,233	20,604	21,841	15,141	15,763	11,654	13,217	10,737		
	4.9			40,929	28,543	29,388	19,515	23,620	14,539	16,369	11,356	14,065	10,520		
	Ground			42,803	27,710	29,368	18,827	24,293	14,110	17,405	11,155	15,472	10,741		
	-4.9		25,706	25,706	42,086	27,571	26,786	18,559	24,086	13,927				17,461	11,502
	-9.8		41,590	41,590	39,143	27,869	28,318	18,667	23,124	14,070				19,460	13,140
	-15		44,260	44,260	33,113	28,620	24,956	19,238						20,847	16,751

 : Over front
 : Over side or 360°

1. The lifting capacity ratings are based on ISO10567.
2. * The maximum lifting capacity is limited by hydraulic rather than tipping load.
3. With the machine standing on level and firm ground, the lifting capacity does not exceed 87% of the hydraulic capacity or 75% of the tipping load.
4. The operator should be familiar with the machinery operation and maintenance manuals. Local regulations concerning the operation safety of machinery must be followed at all times.
5. The lift diagrams only cover machines that are originally built by the XCMG: without lifting chains and any other lifting equipment.
6. When the excavator is used to lift or handle materials, it must comply with local regulations.



Technical Specifications

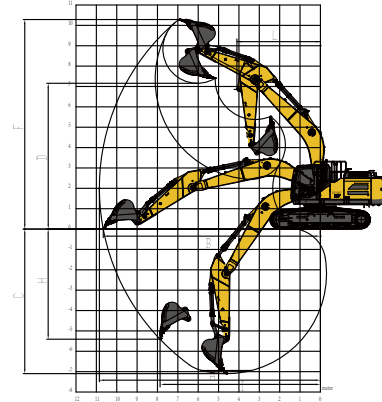
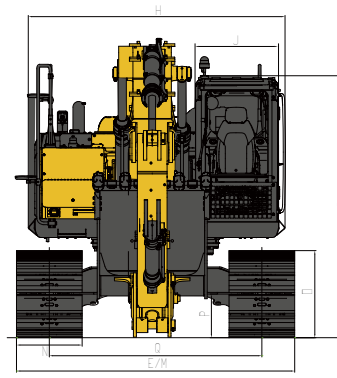
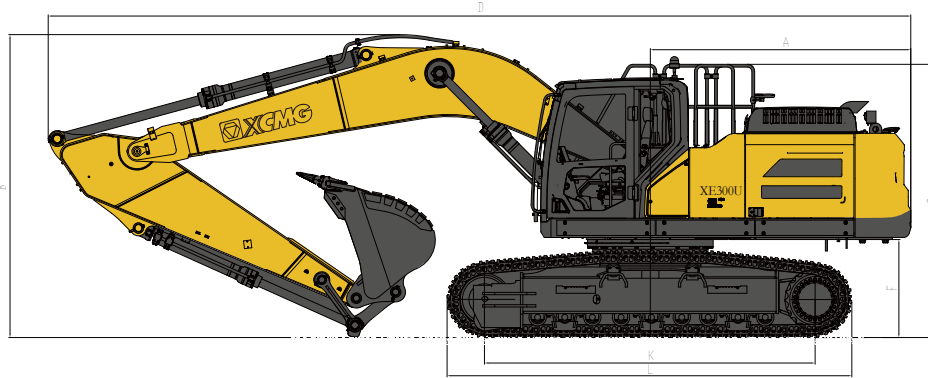

Dimensions

XE300U		ft.in
Boom length - ft.in		20'2"
Arm length - ft.in		10'6"
Bucket capacity - yd ³		2.1
A	Tail swing radius	10'5"
B	Shipping height (boom)	12'1"
C	Shipping height (guardrail)	10'11"
D	Shipping length	34'6"
E	Shipping width	11'1"
F	Counterweight clearance	3'11"
G	Height over cab	10'6"
H	Upper structure width	10'6"
J	Cab width	3'4"
K	Track length on ground	13'3"
L	Track length	16'2"
M	Undercarriage width	11'1"
N	Shoe width std.	31"
O	Track height	3'6"
P	Ground clearance	21"
Q	Track Gauge	8'6"

Working range

XE300U		ft.in
Boom length - ft.in		20'2"
Arm length - ft.in		10'6"
Bucket capacity - yd ³		2.1
A	Max. digging reach	35'7"
B	Max. digging reach (ground)	34'12"
C	Max. digging depth	23'3"
D	Max. loading height	23'6"
E	Loading height	7'12"
F	Max. digging height	33'9"
G	Max. bucket pin height	29'
H	Max. vertical wall depth	17'9"
I	Max. radius vertical	25'9"
J	Max. digging depth (8' level)	22'9"
K	Min. radius 8' line	10'11"
L	Min. swing radius	13'5"

Digging forces (ISO)

XE300U		ft.in
Boom length - ft.in		20'2"
Arm length - ft.in		10'6"
Bucket capacity - yd ³		2.1

Bucket
(Normal/Press. Up) - lbf 46,311 lbf/49,908 lbf

Arm
(Normal/Press. Up) - lbf 34,845 lbf/37,543 lbf