

Hydraulic Excavators XE250U



Rated Power: 194.5 hp
Operating Weight: 60,186 lb
Bucket Capacity: .57 yd³

XCMG North America Corporation
5145 Schirlls Street, Las Vegas, NV 89118
Email: info@xcmgusa.com
Phone: (Las Vegas) 725-605-2777
(Houston) 346-409-2855
Web: www.xcmg-usa.com





Technical Specifications

Engine

Designed to deliver superior performance and fuel efficiency, the Cummins T4F diesel engine fully meets the emissions regulations. To optimize machine performance, the engine uses high-pressure fuel injectors, a VGT™ turbocharger inter-cooler, and electronic engine controls. 4-cycle water-cooled, turbocharged, Selective Catalytic Reduction (SCR) with a Diesel Particulate Filter (DPF).

Model	Cummins B6.7
No. of Cylinders	6
Rated Power at 2000 rpm (ISO 14396/SAE J1995)	194hp @ 2000rpm
Max. Torque at 1500 rpm	625 lbf-ft
Idle Speed (Low-High)	700-1200 rpm
Approximate Engine Dry Weight (with Standard Accessories)	1,118 lb
Piston Displacement	1.8 gal
Bore x Stroke	4.21 in x 4.88 in
Starter	24 V x 10.5 hp
Batteries - Alternator	2 x 12 V, 120 Ah - 24 V, 70 A
Air Filter	Donaldson the Latest PSD Air Filter and Pre-filtered Dust Separator

Weight

	Shoe width (in)	Operating weight (lb)	Ground pressure (psi)
Triple Grouser	24"	59,084	7.7
	28"	59,745	6.7
	31"	60,186	5.9

Hydraulic system

The XICS (XCMG intelligent Control System) is the brain of the excavator - minimizing fuel consumption and enabling the efficiency of the hydraulic system to be optimized for all working conditions. To harmonize the operation of the engine and the hydraulics, the XICS is connected to the engine's electronic control unit (ECU) via a data transfer link.

- The hydraulic system enables independent and combined operations – 2-speed travel offers either increased torque or high travel speed
- A cross-sensing pump system and an auto-deceleration system improve fuel efficiency.
- 8 attachment modes, 3 power modes - flow and pressure control of auxiliary hydraulic circuits from control panel
- Computer-controlled pump flow control

> Pumps flow & system pressure

Main pumps, type:	2 x Variable displacement tandem axial piston pumps
Maximum Flow Rate	2x61.8 gal/min
Pilot Pump, Type:	Gear pump
Maximum Pilot Flow Rate	2x5.3 gal/min
Relief Valve Settings:	
Pressure up	4,975/5,366 psi
Travel	4,975 psi
Swing	3,626 psi
Pilot	566 psi

Undercarriage

Extremely robust construction throughout - made of high-quality, durable materials, with all welded structures designed to limit stresses.

- Lifetime lubricated track rollers, idlers and sprockets fitted with floating seals
- Track shoes made of induction-hardened alloy with triple grouser
- Heat-treated connecting pins
- Hydraulic track adjuster with shock-absorbing tension mechanism

> Number of rollers and track shoes per side

Upper Rollers (Standard Shoe)	2
Lower Rollers	9
Number of Links & Shoes per Side	51
Overall Track Length	15'2"

Cab

Optimal climate control is provided by the integrated air-conditioning and heating system. An automatically controlled fan supplies the pressurized and filtered cab air, which is distributed throughout the cab from multiple vents. The fully adjustable heated air suspension operator's seat includes a seat belt. The operator can adjust the ergonomic seat and joystick console separately according to his preferences.

> Noise emission

Noise level LpA (IOS 6396)	77 dB(A)
Noise level LwA (IOS 6395)	104 dB(A)



Technical Specifications

Component weights

Item	Unit	XE250U	Remarks
Upper structure without front attachment	lb	27,227	With counterweight
Lower structure assembly	lb	19,996	31" shoe
Front assembly	lb	9,912	Without cylinder
counterweight	lb	11,940	Standard counterweight
Boom	ft/lb	19.7/4,332	Without bushing
Arm	ft/lb	9.7/2,094	Without bushing
Bucket	yd ³ /lb	1.57/2,368	Without bushing

Drive

An independent, high-torque axial piston motor through a planetary reduction gearbox drives each track. Two levers with foot pedals guarantee smooth travel with counter-rotation on demand. The track frame protects the travel motors with hydraulically released multi-disc brakes and planetary gears.

Speed & traction

Travel speed (low-high)	2.1/3.2 mph
Maximum traction	49,458 lbf
Maximum gradeability	35°/70%

Buckets

Bucket type	Capacity (yd ³)	Width (in)		Weight (lb)	Boom 19'8"	
		With sidecutters	W/o side cutters		Arm 8'2"	Arm 9'9"
					Shoe 31"	Shoe 31"
GP	1.96	62"	62"	2,379	C	-
	1.83	62"	59"	2,350	B	-
	1.7	61"	57"	2,220	A	C
	1.57	57"	53"	2,091	A	B
HD	1.83	58"	58"	2,663	B	-
	1.7	54"	54"	2,504	A	-
	1.57	55"	52"	2,368	A	B
	1.44	53"	50"	2,229	A	A
	1.31	49"	46"	2,134	A	A
SD	1.7	55"	55"	2,491	A	-
	1.57	51"	51"	2,381	A	-
	1.44	48"	48"	2,271	A	A
	1.18	44"	44"	2,060	A	A

Hydraulic cylinders

High-strength steel piston rods and cylinder bodies. A shock-absorbing (cushion) mechanism fitted in all cylinders for shock-free operation and extended piston life.

Cylinders	Quantity	Bore x rod diameter x stroke (in)
Boom	2	4.9 x 3.5 x 54.7
Arm	1	5.5x3.9x63.3
Bucket	1	5.1x3.5x42.3

Swing mechanism

The swing mechanism uses an axial piston motor to drive a 2-stage planetary reduction gear for maximum torque in oil.

- Swing bearing: single-row, shear-type ball bearing with induction hardened internal gear
- Internal gear and pinion immersed in lubricant

› Swing speed & torque

Maximum swing speed	10.6 rpm
Maximum swing torque	63,062 lbf-ft

› Fluid capacities

Fuel tank	105.7 gal
Cooling system (radiator)	6.9 gal
Urea(DEF) tank	12.7 gal
Hydraulic oil tank	39.6 gal
Engine oil	6.3 gal
Swing reducer	1.4 gal
Travel reducer	2x1.2 gal

GP: General purpose; HD: Heavy duty; SD: Severe duty;

A: Suitable for materials with a density less than or equal to 2100 kg/m³ (131.1 lb/ft³)

B: Suitable for materials with a density less than or equal to 1800 kg/m³ (112.37 lb/ft³)













C: Suitable for materials with a density less than or equal to 1500 kg/m³ (93.64 lb/ft³)

Based on ISO 10567 and SAE J296, arm length without quick-coupler. For reference only.

Lifting Capacities

XE250U

Standard undercarriage width: 11'1" · W/o bucket

Unit: kg/lb	A	5 ft		10 ft		15 ft		20 ft		25 ft		Max. reach			
	B													A (ft)	
Boom 19'8" Arm 9'9" Shoe 31" Counterweight 11,905 lb	25 ft							*11,503	*11,503			*11,834	*1,1834	21.7	
	20 ft							*11,839	*11,839	*11,781	11,043	*11,836	10,677	25.3	
	15 ft					*15,649	*15,649	*13,342	*13,342	*12,249	10,862	*12,053	9,274	27.2	
	10 ft					*20,224	*20,224	*15,466	14,407	*13,254	10,527	*12,401	8,558	28.2	
	5 ft					*24,158	20,209	*17,541	13,726	*14,341	10,178	*12,857	8,291	28.5	
	Ground Line					*26,019	19,530	*18,943	13,259	*15,129	9,916	13,307	8,421	27.9	
	-5 ft				*22,789	*22,789	*26,037	19,362	*19,333	13,060	*15,232	9,810	*14,059	9,029	26.2
	-10 ft		*26,273	*26,273	*34,252	*34,252	*24,451	19,525	*18,401	13,124			*14,762	10,456	23.6
	-15 ft				*28,235	*28,235	*20,617	20,032					*15,349	13,966	19.4

1. The lifting capacity ratings are based on ISO10567.
2. * The maximum lifting capacity is limited by hydraulic rather than tipping load.
3. With the machine standing on level and firm ground, the lifting capacity does not exceed 87% of the hydraulic capacity or 75% of the tipping load.
4. The operator should be familiar with the machinery operation and maintenance manuals. Local regulations concerning the operation safety of machinery must be followed at all times.
5. The lift diagrams only cover machines that are originally built by the XCMG: without lifting chains and any other lifting equipment.
6. When the excavator is used to lift or handle materials, it must comply with local regulations and be equipped with the necessary hose, burst, valves and an overload warning device complying with EN475-5.

 : Rating over front
 : Rating over side



Technical Specifications

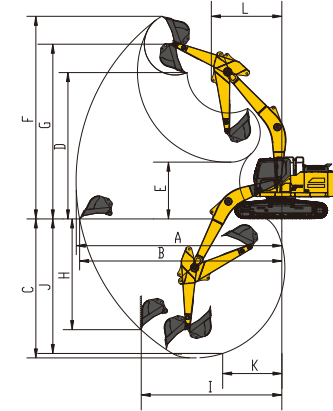
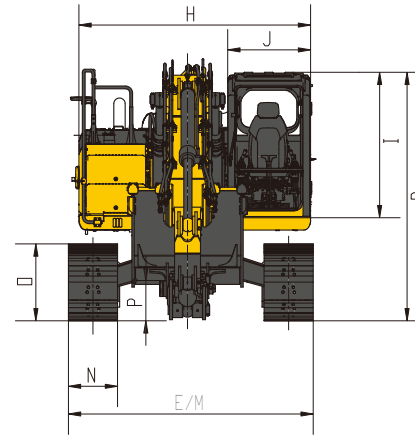
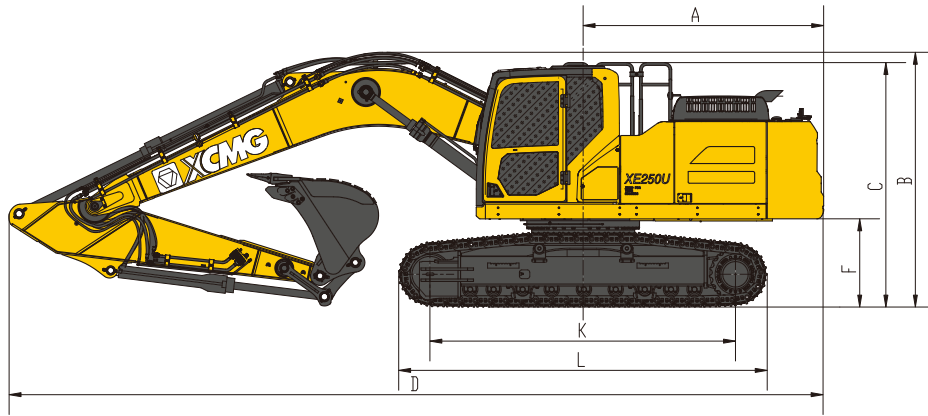

Dimensions

XE250U		ft.in
Boom Length - ft.in		19'8"
Arm Length - ft.in		9'9"
Bucket Capacity - yd ³		1.57
A	Tail swing radius	9'11"
B	Shipping height (boom)	10'6"
C	Shipping height (guardrail)	10'6"
D	Shipping length	33'7"
E	Shipping width	11'1"
F	Counterweight clearance	3'8"
G	Height over cab	9'12"
H	House width	2'9'8"
I	Cab height above house	5'10"
J	Cab width	3'4"
K	Track length on ground	12'7"
L	Track length	15'2"
M	Undercarriage width	11'1"
N	Shoe width std	31"
O	Track height	37"
P	Ground clearance	19"

Working range

XE250U		ft.in
Boom Length - ft.in		19'8"
Arm Length - ft.in		9'9"
Bucket Capacity - yd ³		1.57
A	Max. digging reach	33'8"
B	Max. digging reach (ground)	33'1"
C	Max. digging depth	22'10"
D	Max. loading height	23'4"
E	Min. loading height	9'2"
F	Max. digging height	33'1"
G	Max. bucket pin height	28'5"
H	Max. vertical wall depth	18'2"
I	Max. radius vertical	22'12"
J	Max. digging depth (8' level)	22'2"
K	Min. radius 8' line	9'10"
L	Min. swing radius	11'5"

Digging forces (ISO)

XE250U		
Boom Length - ft.in		19'8"
Arm Length - ft.in		9'9"
Bucket Capacity - yd ³		1.57
Bucket (Normal/Press. Up) - lbf		39,566
Arm (Normal/Press. Up) - lbf		28,101